

Safety Information

Ask a qualified professional such as a licensed general contractor to install your range hood. Electrical wiring must be installed, insulated, and grounded by a licensed electrician familiar with your local codes and regulations. If you don't have this background, do not install the hood yourself. Poor installation or electrical work may result in an injury.

- Range hoods can be heavy to mount, so always ask a friend for help.
- Wear protective gloves when handling the range hood and its filters. The edges can be sharp.
- For residential use only. Do not install your hood in a restaurant or other commercial environment. Our hoods do not abide by the rules and regulations for commercial use.
- Do not use your hood to vent hazardous or explosive materials and vapors. This is incredibly dangerous and may result in serious injury.
- When cleaning the unit, make sure the power is turned off.
- When troubleshooting or replacing the touch panel, circuit board, or other electrical components, turn the range hood off.
- Check your local codes and regulations to see what type of ductwork is required. Some codes require rigid metal ductwork. Do not use flex duct for your range hood, as it can wear down quickly. Air may escape into your walls or attic.
- Never vent your ducted hood into an attic, joists in your ceiling, or a soffit. Always vent the hood to the outside to keep grease, smoke, and unwanted contaminants out of your home.
- Avoid electrical wiring when drilling a hole into your wall or ceiling for ductwork.
- Clean or replace old ductwork with new rigid ductwork to prevent potential grease fires and increase the efficiency of your range hood.
- Seal all joints in your duct system with aluminum tape to prevent air from escaping in your walls or attic.
- Check your local regulations to determine if you need make-up air. When a range hood vents air out of your home, that air has to be replaced. If you operate a powerful range hood (600+ CFM) in a small kitchen, you may need makeup air. We do not sell makeup air kits.
- Clean your range hood filters, grease trays, and the range hood every few weeks. Heavy grease buildup shortens the life of your hood and it may lead to a grease fire.
- All Proline range hoods are ETL certified. They meet all industry standards and regulations to ensure your safety.
- Use the high setting on your range hood to vent heavy smoke or heat in case of emergency. Otherwise, use the lower settings to prolong the life of your hood.
- While your range hood is on, do not leave your cooking area unattended.
- When cooking with oils, do not heat them past their smoke point. If oil starts smoking, turn off the burner and discard any food that came into contact with it. Do not use Extra Virgin Olive Oil in high heat, since it starts to smoke at around 300° Fahrenheit.

In the event of a grease fire:

- Smother the flames with a large lid, pan, or baking sheet. If the fire is small, smother it with baking soda or salt. For larger fires, use a fire extinguisher.
- Turn off all burners.
- Do not touch a flaming pan. This may result in serious burns.
- Keep all flammable materials away from the grease fire. This may include nail polish remover, flour, rubbing alcohol, and hand sanitizer, among other household items.
- Do not pour water on a grease fire. Water will spread the oil around, making the fire more potent and dangerous. Wet towels and rags will also spread the oil, so avoid using these as well.
- If you cannot contain the fire, call the fire department immediately.

Warranty Information

All of our range hoods have a three-year warranty. For the first year, we cover parts and labor. This doesn't include installation.

For the second and third years of your warranty, we'll cover parts only.

This warranty covers every part of your range hood besides the following:

- Range hood filters
- Range hood lights
- Any dents, dings, scratches, or other damage to the outside of the hood

If you're outside of the warranty and your hood is not working properly, call us at (877) 901-5530 and we'll help you resolve your issue. We can typically help fix your Proline range hood at a reasonable price so you don't have to replace the whole thing.

Return Policy

If your range hood is damaged, we accept returns under certain conditions. You can return the hood within 14 days after it was received. If you return the hood inside this 14-day window, it doesn't cost you anything unless the order is undamaged freight. Then, you have to pay for shipping and a restocking fee.

When you receive your hood, be sure to inspect it before the 14-day window expires. Otherwise, you'll be stuck with a damaged range hood.

After that 14 day period and up to 30 days after you receive your hood, you can still return it. But you'll be responsible for a 20% restocking fee as well as the return shipping.

Do not install the hood if it is damaged. We don't accept returns on hoods that are already installed.

Outside of the 30-day period after you receive your hood, you can't return it.

If you bought your hood for a renovation project that's a few months out, remember to inspect it within 14 days of delivery to make sure it's in good condition.



2179 300 W, South Salt Lake, UT 84115
(877) 901-5530
support@prolinerangehoods.com
prolinerangehoods.com
Our support team hours are: Mon-Fri 8:30 am – 5:00 pm MST

INSTALLATION GUIDE

Island Range Hood

Scan for video
installation guide



Before the Installation

1. Check the contents of your box.

They should include, depending on the specific model of your hood:

- Range hood wall or ceiling mounting bracket hardware
- Chimney(s)
- Support brackets
- Transition duct
- Hardware packet with screws

As you unpack your hood, remove any protective film from chimney sleeves, the filters, or the range hood before installation.

2. Inspect your range hood.

- Plug in and test controls, lights, and fan.
- Inspect for any damage caused during shipping.
- Within 14 days of receiving the hood, call us at (877) 901-5530 or email support@prolinerangehoods.com to report any damage.

3. Make sure you can run power to the hood.

Before you begin the installation, ensure that you can run electricity to it without too much trouble. Make sure you know where you will plug in your vent hood and that you have the necessary extension cords before you proceed with the installation.

NOTE: Do not install the hood if it's damaged or you're unsatisfied with it.

Wall Range Hood Installation

What You Will Need

- Power Drill
- Screwdrivers
- Drill Bits
- Tape Measure
- Masking Tape
- Pencil/Marker
- Metal or Aluminum HVAC Tape
- Plumb Bob/Laser Level
- Scissors/Box Cutter
- Drywall Saw
- 2x4s or Appropriate Framing Material*

***2x4s and other additional framing material may be required if you're installing extra supports, or if ceiling joists are not available where you're mounting the hood.**

Install Ductwork

1. Plan where your ductwork will be located.

- Install your ductwork in the shortest unobstructed path to the outside of your home.
- Select a path that avoids studs, electrical wires, and other obstacles in your walls.

Venting Options

The best option is to vent vertically through the roof if possible, since hot air rises. See the diagram below.

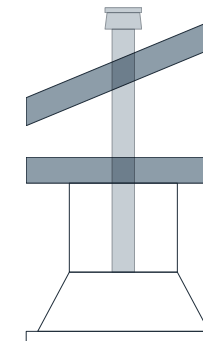

Best Practices when Ducting Your Range Hood

- Include at least 18" straight from the transition piece before using an elbow in the duct.
- Make sure there is at least 24" of straight duct between other elbows.
- Use rigid galvanized steel or metal HVAC ducting only.
- Do not terminate the vent system into an attic, or another enclosed area.
- Do not use 4" (10.2 cm) laundry-type wall caps.
- Do not use plastic flexible duct.
- Do not use more than 30' of ductwork.
- Do not reduce the diameter of your ductwork from the hood outlet size. This will lead to poor performance.
- A round duct is more efficient than a rectangular duct. Both are viable choices, but if you have the option, use round ductwork.
- For each elbow in your duct, reduce the total length of your duct run by 5'.
- Do not use more than two elbows in your ductwork. The fewer the elbows, the better.



2179 300 W, South Salt Lake, UT 84115
Call (877) 901-5530
support@prolinerangehoods.com
prolinerangehoods.com
Our Support team hours are: Mon-Fri 8:30 am - 5:00 pm MST

2. Make measurements and markings on your ceiling.

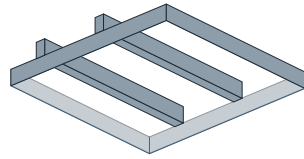

- Find and mark the joists on your ceiling. You can either look in your attic for the joists to get a rough idea of where they are located. Or, get on a ladder and knock on your ceiling. Listen for a solid sound to find a joist.

Mark the joists nearest to your installation area on each side with a marking pencil or pen.

- Find and mark the center point directly above your cooktop using a plumb bob or laser level to line them up accurately.
- Place the ceiling bracket on the ceiling around the center point and trace the outline of the ceiling bracket.

Make sure it is square with your cooktop. Ensure that the bracket intersects the joists in your ceiling. If it doesn't, you must build a support to secure the ceiling bracket.

Mark the 4 corners of the ceiling bracket where you will drill the holes.

Trace a circle inside the outline of the ceiling bracket where the ducting will go. Set the duct against your ceiling to get the exact shape.

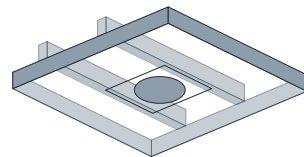

3. Cut a hole 1-2 inches larger than your duct diameter in your ceiling or wall.

- Use the duct transition piece as a guide to determine the size of this hole.
- Trace around the transition on your ceiling or wall.
- Use your sheetrock saw to cut the hole about one to two inches larger than the transition

4. Thread the ductwork from the exterior of your home to the range hood.

- If you can hop in your attic or basement, these are generally the easiest places to thread ductwork.
- Otherwise, you may have to choose a couple of areas to cut out access points in your ceiling or wall.
- If the ductwork does not fit through the hole in your roof, do not try to force it. Use a compass to trace a new line and cut out a larger hole. The duct should be easy to pull through and it should not brush up against the ceiling.

Before you go cutting holes in your home, if you aren't certain of what is inside the wall where you are cutting, consult a contractor.

Hood Installation – Step 1

Install the ceiling bracket.

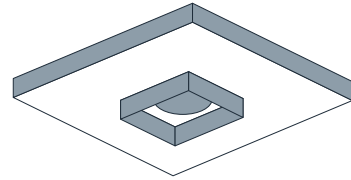

- Now that you've made your measurements and installed ductwork, drill holes into the four ceiling marks from Step 2 above.
- These holes must hit ceiling joists or the added ceiling support. **The support bracket needs to be supported by something that will hold the weight of twice the range hood.**
- Drywall will not do the job you need to find your ceiling supports and drill the bracket into those. Or install your own ceiling support.
- Place the chimney bracket against the ceiling and screw it securely into place.
- Drop the ducting and electrical work through the ceiling

Step 2

Install the support brackets.

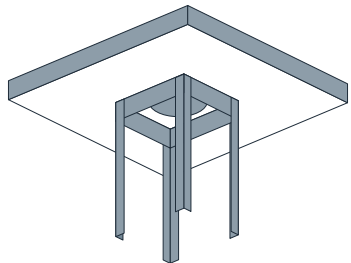

- Place brackets vertically inside the four corners of the ceiling bracket.
- Extend the brackets to the appropriate length. The bottom of the hood should be 28" to 36" above the cooktop. For an outdoor kitchen, the bottom of your hood should be 36" to 42" over a BBQ grill.
- **Hoods mounted below 28" from your cooktop may be susceptible to heat or fire damage.**
- **Hoods mounted above 36" from your cooktop will perform poorly and become inefficient.**
- Screw all four support brackets to the ceiling mounting bracket with two screws on each bracket.

Step 3

Install the chimney.

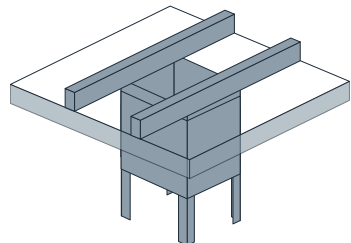

- Slide the top chimney sleeve over the support brackets, covering the ceiling bracket.
- Screw the chimney into place at the top of the ceiling bracket.

- Slide bottom chimney sleeve over the top chimney sleeve. Make sure the vent on the top chimney is towards the top.
- Adjust until the bottom chimney sleeve is a few inches above the bottom of the support brackets.
- You may want to use masking tape to help hold the chimney in place while you proceed to the next step.

Step 4

Mount your island range hood.

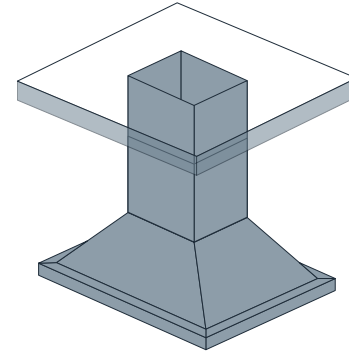

- If your hood comes with a transition ducting piece, secure it to the base of your hood before mounting.
- Place the base of the hood directly under the chimney.
- Screw hood to the support brackets on all four corners.
- Feed electrical and ducting work through the chimney.
- Power your hood by hardwiring it to a power source or by plugging it in to a nearby electrical outlet. Always consult an electrician before directly wiring a hood to a power source.
- Slide the outer chimney sleeve down into place, meeting the top of the hood.

Step 5

Attach and seal the ductwork to the range hood.

- Attach the duct transition piece to the top of your range hood. Then, use the included screws to attach the transition to your ductwork. The ductwork should already be punched through the ceiling and ready to hook up to the range hood before beginning the installation.
- Use aluminum tape to seal the ductwork to the transition piece. For the best results, make sure that you seal the duct air tight.
- Attach a wall or roof cap to the exterior wall or roof. A cap helps keep debris and dirt from entering your duct. While an island hood must vent through the ceiling, the duct run can terminate on an exterior wall or roof. Use caulking to seal exterior openings around the wall or roof cap.

After the Installation - Final Steps

Now you just need to do a few quick things to ensure that your installation went smoothly.

Tighten the screws that connect the support brackets to the hood. Double check these screws and make sure they are tight so your hood is secure.

Assemble and insert baffle filters and the grease tray (if included). If your hood comes with a grease tray, slide this into the back of the range hood before inserting the filters.

Then, angle the filters to set them into the back of your hood first and slide them to the front of the hood.

Note: Be careful when handling the filters. They may be sharp.

Some filters have handles and a catch mechanism on the front of the filter. If your filter comes with these parts, insert the screws for each part of the handle through the screw hole.

Then tighten them by hand.

The catch mechanism screws into the back of the hood. You can do this by hand.

Run Power to the Hood

All range hoods come with a 4' cord. If this isn't long enough, you can use an extension cord.

Power the hood by connecting the three pronged plug to a nearby electrical outlet or by hardwiring the hood to a power source. Always consult an electrician before directly wiring a hood to a power source.

**That wraps up your wall range hood installation!
Great work!**

We are happy to help you with any questions or concerns you may have. Please create a ticket, email us at support@prolinerrangehoods.com or call our support line at (877) 901-5530 to talk to a live representative.